

Series
VENTS VUT R TN H EC
VENTS VUT R TN EH EC

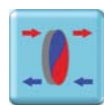

The heat recovery air handling units in sound- and heat-insulated casings are equipped with a rotary heat exchanger and a built-in heat pump. Air capacity up to **955 m³/h**, heat recovery efficiency up to 85%.



HEAT-RECOVERY VENTILATION



HEATING



COOLING

Two-Stage Energy Saving System:

Stage 1: Heat energy recovery by means of the rotary heat exchanger (up to **85%** efficiency).



Advantages:

- High energy efficiency.
- Low energy consumption.

Stage 2: Supply air heating by the heat pump utilizing the low-potential extract air thermal energy.



- Energy-saving solution.
- Maximum occupant comfort.

Description

The **VUT R TN H EC / VUT R TN EH EC** are fully-featured air handling units designed to ensure air filtration, fresh air supply and stale air extract. During operation the extract air heat is transferred to the supply air stream by the rotary heat exchanger. A ventilation system comprising a rotary heat exchanger and a heat pump can effectively supply fresh air at a comfortable temperature to the premises thereby reducing the load on the existing heating or cooling systems in the building. When the heat pump and the rotary heat exchanger work simultaneously the energy released to the energy consumed ratio is 1:8 meaning that each kilowatt of electricity generates up to 8 kW of heat output. All the models are designed for connection to Ø 160 or 250 mm round air ducts.

Modifications

The **VUT R TN H EC** models are equipped with a rotary heat exchanger and a heat pump without preheating.

The **VUT R TN EH EC** models are equipped with a rotary heat exchanger and a heat pump as well as a preheater.

Casing

The casing framework consists of three-layer panels made of aluzinc and internally filled with a 25 mm mineral wool layer for reliable heat- and sound-insulation. Due to the specially designed removable side panels the unit requires little service space and access to the unit components.

Filter

The unit has two integrated class G4 filters to filtrate intake and extract air. The unit can be supplied with a class F7 supply filter (option).

Motor

The units are equipped with high-efficient direct current electronically commutated (EC) motors

with an external rotor and backward curved impeller blades. As of today such motors are the most state-of-the-art and progressive energy saving solution. EC motors are featured with high performance and well controllable speed range. Premium efficiency reaching 90% is the definite advantage of electronically-commutated motors.

Rotary heat exchanger

The rotary heat exchanger is a rotating short cylinder filled with multiple layers of corrugated aluminium strip in such a way so as to ensure free passage of the supply and exhaust air streams. As the wheel rotates the contact patch repeatedly moves from the intake to the extract air stream causing heating and cooling cycles thus transferring heat and humidity from the warmer air stream to the cooler one. The rotary heat exchanger transfers the sensible and latent heat from the warm air stream to the cool one enabling partial moisture transport back to the premises. By virtue of design the rotary heat exchanger

Designation key:

Series	Heat exchanger type	Rated air capacity [m ³ /h]	Modification	Preheater	Duct connection	Motor type	Control panel
VENTS VUT	R – rotary heat exchanger	400; 700; 900	TN – Heat Pump	– no; E – Electric	H – horizontal	EC – synchronous electronically commutated motor	A17 – th-Tune; A18 – pGD1

Accessories



page 368 page 368 page 430 page 435 page 440 page 443 page 484 page 485

is hardly prone to freezing (the chances of ice buildup within the normal temperature and humidity range are almost zero).

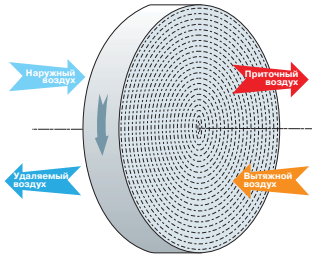

Rotary heat exchanger operating logic

Heat pump

The unit is cooled by a reversible heat pump which warms up or cools down the air as necessary. The rotary air compressors used combine high performance with low noise levels. The units utilize the R410A high-tech two-component cooling agent as the heat pump working fluid offering exceptional thermodynamic properties without depleting the ozone layer.

The highly efficient rotary heat exchanger recovers most thermal energy contained in the extract air and transfers it to the intake air. The heat pump transfers the remaining part of the low-potential extract air thermal energy to the intake air stream maintaining the user-defined room air temperature.

Heater

The **VUT R TN EH EC** units are equipped with a posistor electric heater which pre-heats intake air when the ambient temperature drops below the normal range. Preheating reduces the number of heat pump defrosting cycles thus increasing the overall operational efficiency of the unit. The heater is divided into two active elements for added power consumption economy without compromising the heating capacity.

Control and automation

The unit is equipped with a built-in automation system and the **A17** (th-Tune) or **A18** (pGD1) multifunctional sensor control panel.



A17 control panel



A18 control panel

The standard delivery set includes a 10 m cable for connection to the control panel.

Main operating modes of the unit:



Auto mode:

The unit runs in the automatic supply and exhaust mode maintaining the user-defined room temperature.



Heating mode:

The unit runs in the supply and exhaust mode maintaining the room temperature above the pre-set threshold level. As soon as the room temperature drops below the pre-set threshold the heat exchanger and the heat pump are activated (in the heating mode).



Cooling mode:

The unit runs in the supply and exhaust mode maintaining the room temperature below the pre-set threshold level. As soon as the room temperature exceeds the pre-set threshold the rotary heat exchanger and the heat pump are activated (in the cooling mode).



Heat Recovery mode:

The unit runs in the supply and exhaust mode maintaining the room temperature by means of the rotary heat exchanger only without engaging the heat pump. This mode is activated automatically while in the **Auto**, **Heating** or **Cooling** mode if the heat exchanger alone can maintain the user-defined room temperature without engaging the heat pump. This mode can also be entered manually via the controller menu or the **A18** (pGD1) control panel.



Ventilation mode:

The unit runs in the supply and exhaust mode without maintaining the pre-set room temperature. The heat exchanger and heat pump operation is blocked. Room temperature adjustment is not available. This operation mode is only available via the **A18** (pGD1) control panel.



Defrosting mode:

This mode is enabled automatically (upon elapsing of the pre-set time range and/or reaching the temperature threshold) while running in the **Auto** and **Heating** modes to prevent icing of the heat pump heat exchanger. While in the **Defrosting** mode the fan operation is blocked. Upon the **Defrosting** mode deactivation the unit reverts to the previous operation mode automatically. While in the **Defrosting** mode the operation modes switching is not available.



Preheating mode:

While running in the **Auto** or **Heating** modes at low ambient temperatures the intake air fed into the unit is warmed up by the electric preheater. This mode is enabled automatically upon the ambient temperature dropping below -8 °C. If the outdoor air temperature reaches above -8 °C the Preheating mode is disabled. This mode is only available in factory configurations of the **VUT R TN EH EC** models equipped with an electric heater. The Preheating mode implementation in a **VUT R TN H EC** requires upgrading the unit with a series-produced electric heater (purchased separately) installed into the unit casing. The heater may only be installed by a service provider certified by the unit manufacturer.



Recirculation mode:

This optional mode requires upgrading the unit with an external recirculation valve (purchased separately). The recirculation mode is enabled automatically at subzero ambient temperatures allowing a considerable reduction of unit energy consumption due to a partial redirection of the exhaust air into the supply duct of the unit.

Intelligent control systems:



Limit Function technology:

Automatic air flow reduction to maintain the user-defined temperature. If the unit cannot execute the user-defined room temperature setting after running in the **Auto** or **Heating** mode for 20 minutes the air flow rate (fan speed) is reduced automatically. The unit reverts to the original fan operation mode upon reaching the

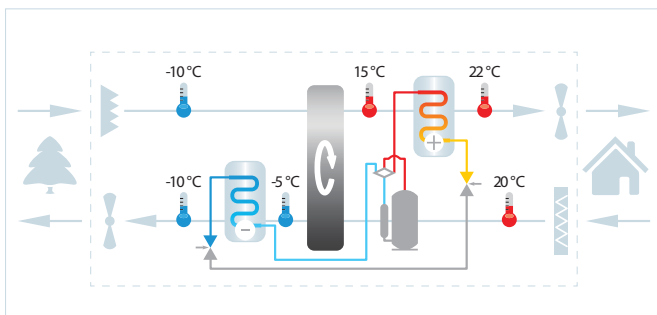

Unit operation in the Heat Recovery and Air Heating ventilation mode

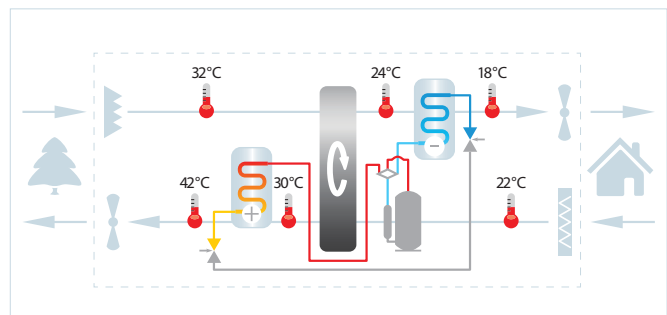



Unit operation in the Heat Recovery and Air Cooling ventilation mode

VENTS
HEAT RECOVERY AIR HANDLING UNITS
VUT R TN/EH EC /
VUT R TN/H EC

target air temperature as defined by the user. While in the **Limit Function** mode the air flow adjustment is not available.

 **Warming-Up technology:** Blocks cold air supply into the premises in the **Auto** or **Heating** mode. Implemented by warming up the heat pump heat exchanger in the supply air duct while the supply fan remains deactivated. The **Warming-Up** mode is enabled after the **Defrosting** mode as well as upon the first start if the outdoor air temperature is below +10 °C. Upon completion of the **Warming-Up** cycle the unit reverts to the original **Auto** or **Heating** mode.

 **Higher Speed technology:** Automatic increase of the extract air flow capacity while in the **Cooling** mode to prevent excessive pressure build-up in the heat pump. The extract fan reverts to the initial speed once the pressure has dropped to normal.

 **Smart Safe technology:** Automatically protects the unit from operating outside the safe performance range. The unit is equipped with an intelligent hardware protection system ensuring its safe and reliable performance within the permissible range of ambient temperature conditions. Therefore, the unit is able to adjust operating parameters or disable certain units and assemblies to compensate for abnormal operating conditions in order to prevent equipment failure.

 **Heat Pump Protection technology:** Automatically prevents heat pump failure:

- ▶ Protection against abnormally high or low pressure build-up. If the coolant pressure reaches beyond the safe performance range the pressure sensors send signals to the unit controller to power off the heat pump compressor. The compressor power is restored once the pressure has reverted to normal.

- ▶ Compressor thermal overheating protection. The compressor is powered off when its casing temperature becomes abnormally high. The power is restored once the casing temperature has dropped to the normal performance range.

- ▶ Delayed Start technology: Protects the compressor from cycling (by blocking too frequent activation/deactivation of the compressor).

 **Serviceability technology:** The design solutions provide for easy access to the unit parts and components, facilitate its maintenance and replacement of the consumables and wear parts and ensure high serviceability of the entire air handling unit.

 **Fresh Air technology:** Ensures clean air supply into the premises. The unit is equipped with a class G4 filter (a class F7 filter is available as an option). The control system

monitors the filter performance automatically and generates replacement signals as necessary.

 **Ozone Protection technology:** The heat pump utilizes the R410A high-tech two-component cooling agent which does not deplete the ozone layer.

 **Save Energy technology:** A comprehensive engineering and technical approach to reducing the unit energy consumption which comprises the following elements:

- ▶ a posistor electric preheater with two active elements;
- ▶ an upgraded thermal insulation of the supply chamber;
- ▶ an integral high-performance air-to-air heat pump;
- ▶ an adjustable fan speed;
- ▶ automatic heat exchanger and heat pump activation/deactivation;
- ▶ electric heater deactivation in the Defrosting mode.

- ▶ the «Intelligent-vents-software» unit control software for maintaining optimum performance characteristics at low energy consumption based on the exclusive control algorithms.

 **Low Noise technology:** A comprehensive engineering and technical approach to reducing the unit noise levels during operation comprising the following elements:

- ▶ a heat pump integrated into the sound-insulated unit casing;
- ▶ adjustable-speed fans;
- ▶ a low-noise rotary compressor.

 **Autorestart technology:** The unit memorizes the current operation mode in case of a power outage.

 **Simple Use technology:** The units are pre-assembled at the factory and are ready for operation. The installation and maintenance costs are reduced to a bare minimum. The unit operation does not require any special training due to a simple and intuitive interface.

 **CO₂ Control technology:** Maintains the CO₂ level in the ventilated premises below the user-defined threshold level. Should the CO₂ concentration in the premises airspace become abnormally high the unit increases the air exchange rate automatically. This option is available only with the external CO₂ sensor with a 0-10 V output signal (purchased separately).

 **RH Control technology:** Maintains the relative humidity level in the ventilated premises below the user-defined threshold level. Should the relative humidity become abnormally high the unit increases the air exchange rate automatically. This option is available only with the



A17 (th-Tune) control panel in a special configuration or the external relative humidity control sensor with a 0-10 V output signal (purchased separately).

 **Rapid Access to Set Mode technology:** The bigger the difference between the ambient temperature and the user-defined setpoint the faster the heat pump activates.

■ Mounting

The unit is designed for mounting to a horizontal plane, suspension to a ceiling or wall mounting by means of brackets. Service access must be provided on the side panel side.

Control Panel Functionality

Functions	A17 (th-Tune) Control Panel	A18 (pGD1) Control Panel
		
Turning the unit on / off	✓	✓
Fan speed selection	✓	✓
Unit operation mode selection	✓	✓
Temperature setup	✓	✓
Scheduled operation on / off	✓	✓
Scheduled operation programming	✓	✓
Temperature monitoring:	✓	✓
• indoor air	✓	✓
• supply air	✓	✓
• user-defined temperature	✓	✓
• defrosting sensor	✗	✓
• downstream of the heat exchanger	✗	✓
• intake air	✗	✓
Changing of user-accessible factory settings	✗	✓
Changing of service factory settings*	✗	✓*

*Password-protected

Overall Dimensions:

Model	Dimensions [mm]				
	∅D	B	H	L	L1
VUT R 400 TN H EC / 400 TN EH EC	159	648	710	1250	1421
VUT R 700 TN H EC / 700 TN EH EC	249	748	750	1667	–
VUT R 900 TN H EC / 900 TN EH EC	249	748	750	1667	–

VUT R 400 TN H EC
VUT R 400 TN EH EC

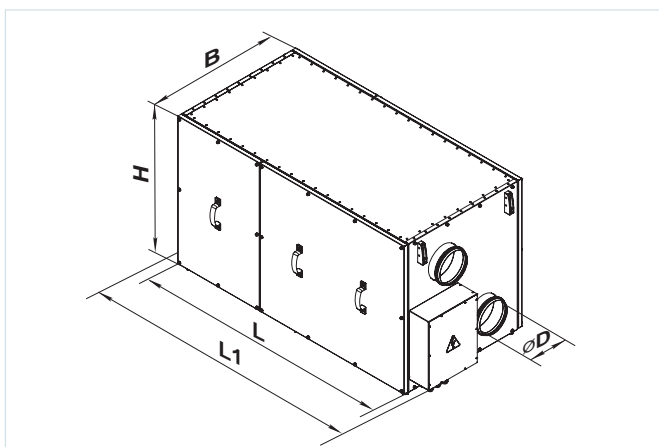

VUT R 700 TN H EC / BYT P 700 TN EH EC
VUT R 900 TN H EC / BYT P 900 TN EH EC

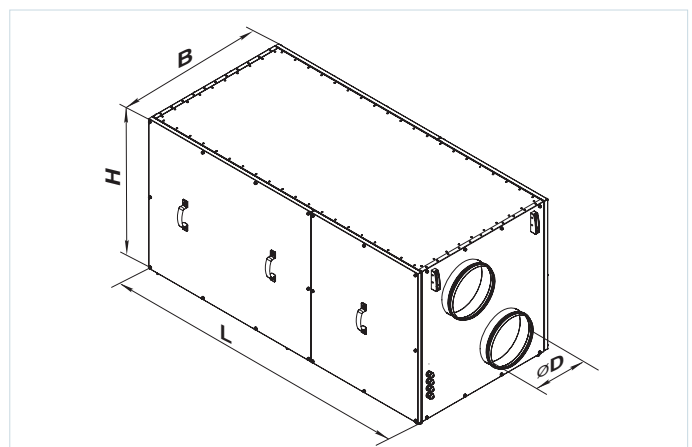

VENTS
 HEAT RECOVERY AIR HANDLING UNITS
 VUT R TNHEC /
 VUT R TNEHEC

HEAT RECOVERY AIR HANDLING UNITS

Accessories to air handling units:

Model	G4 replaceable filter (panel type)	G4 replaceable filter (pocket type)	F7 replaceable filter (pocket type)
VUT R 400 TN H EC / 400 TN EH EC	SF VUT R 400 TN H/EH G4	SFK VUT R 400 TN H/EH G4	SFK VUT R 400 TN H/EH F7
VUT R 700 TN H EC / 700 TN EH EC	SF VUT R 700-900 TN H/EH G4	SFK VUT R 700-900 TN H/EH G4	SFK VUT R 700-900 TN H/EH F7
VUT R 900 TN H EC / 900 TN EH EC			

Technical data:

		VUT R 400 TN H EC	VUT R 700 TN H EC	VUT R 900 TN H EC	VUT R 400 TN EH EC	VUT R 700 TN EH EC	VUT R 900 TN EH EC
General Parameters							
Air capacity [m ³ /h]		520	830	955	520	830	955
Transported air temperature [°C]		-10...+40			-25...+40		
Heat recovery efficiency [%] up to 85		up to 85					
Sound pressure level at 3 m [dBA]		45	52	58	45	52	58
Casing material		aluzinc					
Weight [kg]		150	160	165	150	160	165
Connected air duct diameter [mm]		160	250	250	160	250	250
Heat exchanger type		rotary					
Heat exchanger material		aluminium					
Filter	Extract filter	G4					
	Supply filter	G4 (F7*)					
Electrical parameters							
Voltage [V / 50 Hz]		1~ 230					
Maximum power in Heat Recovery mode, [kW]		0.31	0.36	0.46	0.31	0.36	0.46
Maximum power in Heat Recovery + Heat Pump mode, [kW]		0.745	0.94	1.195	0.745	0.94	1.195
Maximum power in Heat Recovery + Heat Pump + Preheating mode, [kW]		–	–	–	2.145	3.74	3.995
Maximum current consumption, [A]		4.6	5.7	6.7	10.9	18.5	19.4
Air-handling unit energy efficiency	in Heating mode (COP)	6	6.5	6.5	6	6.5	6.5
	in Cooling mode (ERR)	4	4.15	4.25	4	4.15	4.25
Heat pump specifications							
Coolant		R410A					
Coolant weigh, [kg]		0.8	1.6	2	0.8	1.6	2
Thermal performance in the Heating mode, [kW] at t ₀ = +7 °C; t _k = +45 °C**		1.56	2.6	3.25	1.56	2.6	3.25
Thermal performance in the Cooling mode, [kW] at t ₀ = +7 °C; t _k = +45 °C**		1.2	2	2.5	1.2	2	2.5
Compressor Type		sealed, rotary					
Setpoint temperature range in Cooling / Heating modes, [°C]		+16...+30					

* optional, ** t₀ is the coolant boiling temperature; t_k is the coolant condensation temperature.

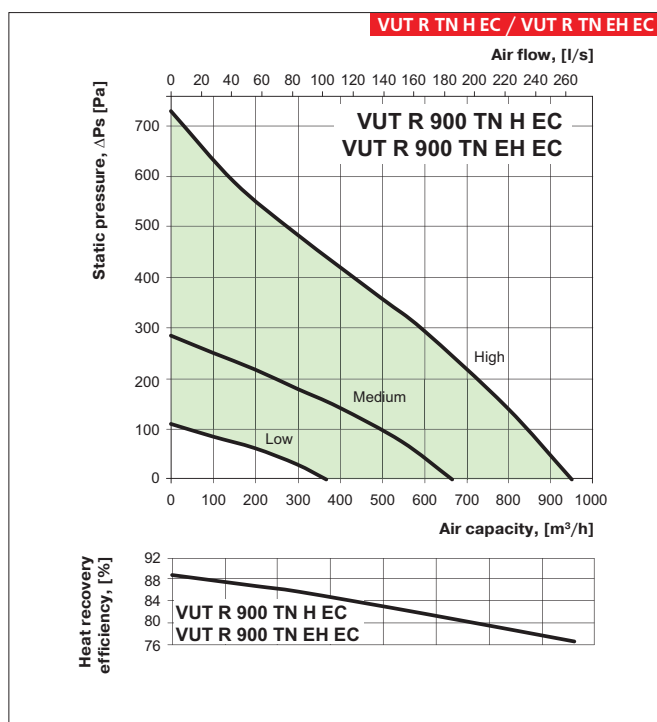
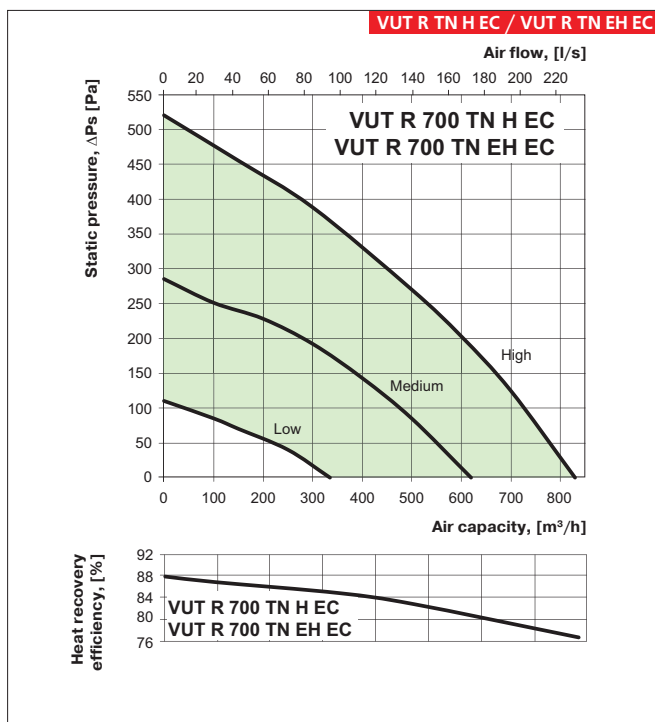
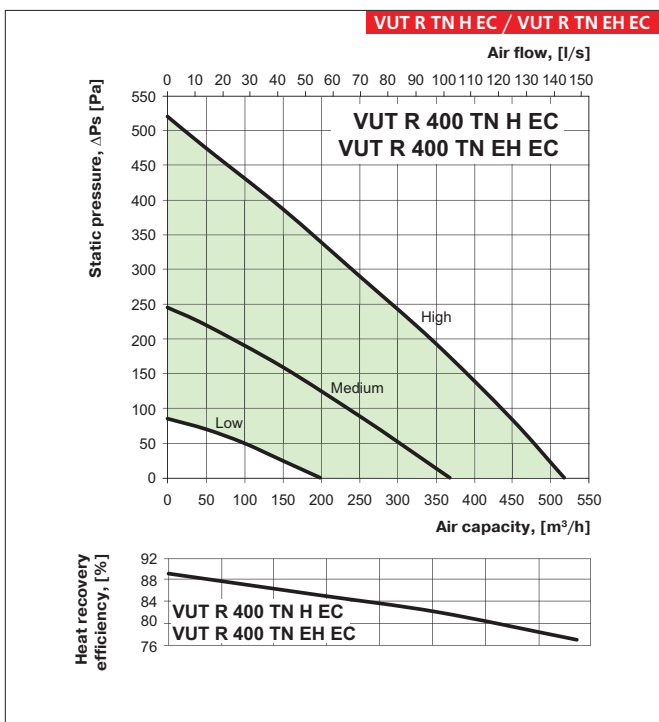

VENTS
 HEAT RECOVERY AIR HANDLING UNITS
 VUT R TN H EC / VUT R TN EH EC
 VUT R TN E H EC

Heat pump technical characteristics in the Heating mode:

VUT R 400 TN H EC / VUT R 400 TN EH EC												
Speed	Air flow rate		Room air temperature, [°C]		Intake air temperature, [°C]		Supply air temperature, [°C]		Electric power consumption, [kW]	COP*, W/W	COP*, BTU/W	Q _{heat} , [kW]
	% of max.	[m ³ /h]	Dry-bulb temperature	Wet-bulb temperature (relative humidity)	Dry-bulb temperature	Wet-bulb temperature (relative humidity)	Dry-bulb temperature	Wet-bulb temperature (relative humidity)				
High	100	400					26	14 (~25%)	0.585	4.3	14.8	2.53
Medium	70	280	20	12 (~38%)	7	6 (~86%)	28	15 (~23%)	0.485	4	13.8	1.96
Low	40	160					35	17 (~14%)	0.475	3.1	10.7	1.49
High	100	400	20	12 (~38%)	2	1 (~80%)	25	12 (~18%)	0.58	5.3	18	3.07
Medium	70	280					27	13 (~17%)	0.475	4.9	16.8	2.33
Low	40	160					34	16 (~12.5%)	0.465	3.7	12.5	1.71
High	100	400					21	8 (~8%)	0.56	7.1	24.4	4
Medium	70	280	20	12 (~38%)	-7	-8 (~70%)	22	9 (~8%)	0.45	6.4	21.9	2.89
Low	40	160					25	10 (~8%)	0.44	4.1	14.1	1.81

* – Important! The temperature parameters and the COP and ERR factors were defined at the temperature-humidity conditions as per the EN 13141 -7:2010 standard. The factors were calculated based on the assumption of continuous heat pump operation whereas the cyclic heat pump operation was disregarded.

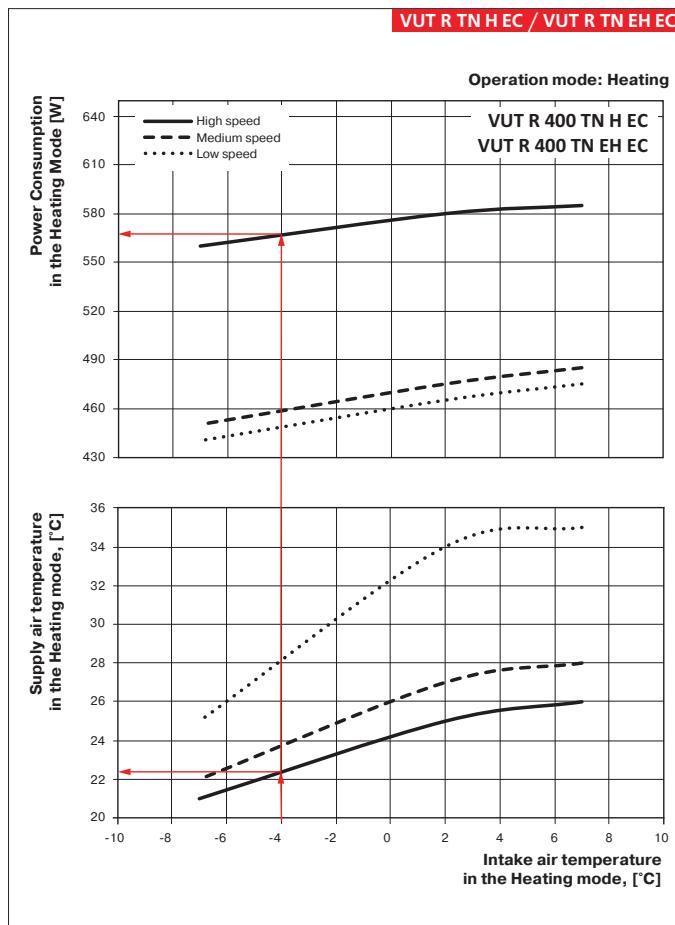

Heat pump technical characteristics in the **Cooling** mode:

VUT R 400 TN H EC / VUT R 400 TN EH EC												
Speed	Air flow rate		Room air temperature, [°C]		Intake air temperature, [°C]		Supply air temperature, [°C]		Electric power consumption, [kW]	COP*, W/W	COP*, BTU/W	Q _{heat} , kW
	% of max.	[m³/h]	Dry-bulb temperature	Wet-bulb temperature (relative humidity)	Dry-bulb temperature	Wet-bulb temperature (relative humidity)	Dry-bulb temperature	Wet-bulb temperature (relative humidity)				
High	100	400					23	21 (~85%)	0.664	2.4	8.2	1.6
Medium	70	280	27	19 (~47.5%)	35	24 (~40%)	22	20.5 (~85%)	0.560	2.2	7.4	1.21
Low	40	160					20	19 (~90%)	0.554	1.8	6.2	1.01
High	100	400					19	16.5 (~78%)	0.619	1.7	5.9	1.07
Medium	70	280	27	19 (~47.5%)	27	19 (~47.5%)	18	15.5 (~78%)	0.522	1.6	5.5	0.84
Low	40	160					15	14 (~88%)	0.495	1.6	5.5	0.8

* – Important! The temperature parameters and the COP and ERR factors were defined at the temperature-humidity conditions as per the EN 13141 -7:2010 standard. The factors were calculated based on the assumption of continuous heat pump operation whereas the cyclic heat pump operation was disregarded.

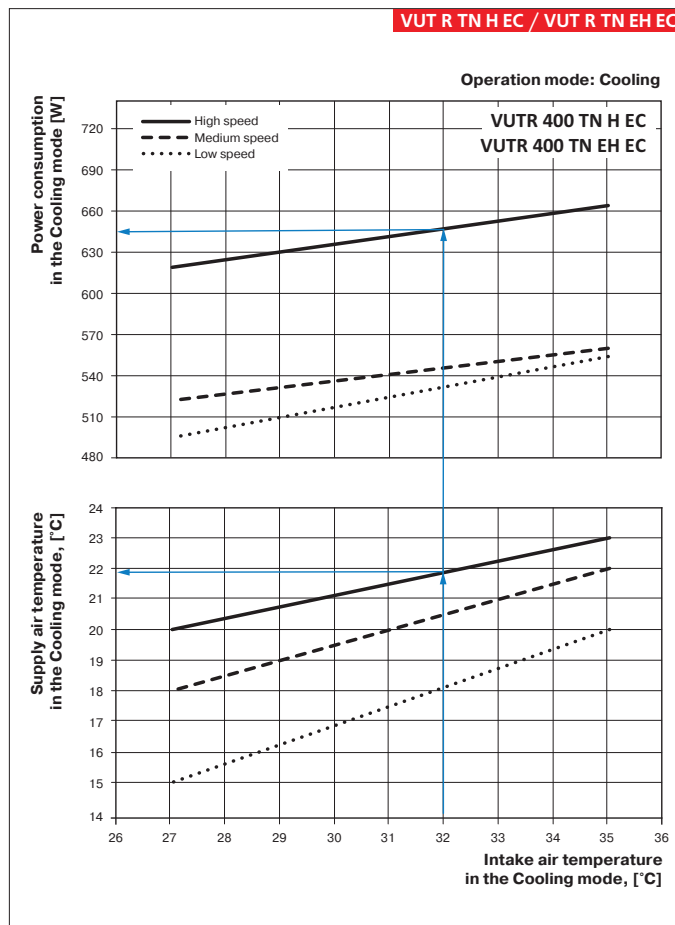

VENTS
 HEAT RECOVERY AIR HANDLING UNITS
 VUT R TN H EC /
 VUT R TN EH EC

Heat pump technical characteristics in the Heating mode:

VUT R 700 TN H EC / VUT R 700 TN EH EC												
Speed	Air flow rate		Room air temperature, [°C]		Intake air temperature, [°C]		Supply air temperature, [°C]		Electric power consumption, [kW]	COP*, W/W	COP*, BTU/W	Q _{heat} , [kW]
	% of max.	[m³/h]	Dry-bulb temperature	Wet-bulb temperature (relative humidity)	Dry-bulb temperature	Wet-bulb temperature (relative humidity)	Dry-bulb temperature	Wet-bulb temperature (relative humidity)				
Speed	100	700					26	14 (~25%)	0.695	6.4	21.8	4.43
High	70	490	20	12 (~38%)	7	6 (~86%)	28	15 (~23%)	0.58	5.9	20.2	3.43
Medium	40	280					35	17 (~14%)	0.52	5.0	17.1	2.61
Speed	100	700					25	12 (~18%)	0.69	7.8	26.5	5.37
High	70	490	20	12 (~38%)	2	1 (~80%)	27	13 (~17%)	0.57	7.2	24.4	4.08
Medium	40	280					34	16 (~12.5%)	0.505	5.9	20.2	2.99
Speed	100	700					21	8 (~8%)	0.67	10.4	35.6	7.00
High	70	490	20	12 (~38%)	-7	-8 (~70%)	22	9 (~8%)	0.555	9.1	31.1	5.06
Medium	40	280					25	10 (~8%)	0.485	6.5	22.3	3.17

* – Important! The temperature parameters and the COP and ERR factors were defined at the temperature-humidity conditions as per the EN 13141 -7:2010 standard. The factors were calculated based on the assumption of continuous heat pump operation whereas the cyclic heat pump operation was disregarded.

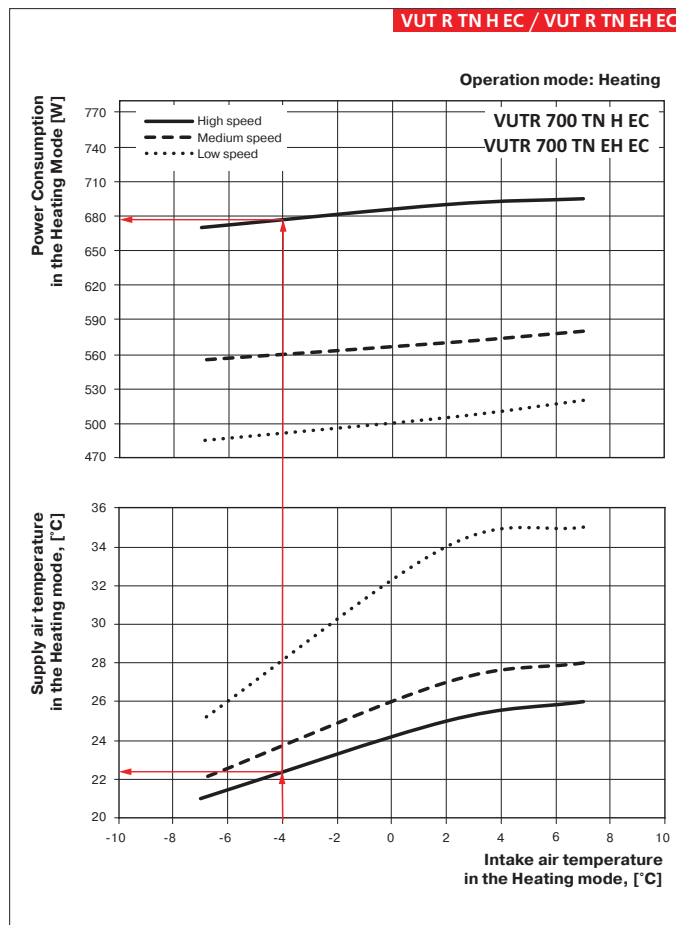

Heat pump technical characteristics in the **Cooling** mode:

VUT R 700 TN H EC / VUT R 700 TN EH EC												
Speed	Air flow rate		Room air temperature, [°C]		Intake air temperature, [°C]		Supply air temperature, [°C]		Electric power consumption, [kW]	COP*, W/W	COP*, BTU/W	Q _{heat} , kW
	% of max.	[m³/h]	Dry-bulb temperature	Wet-bulb temperature (relative humidity)	Dry-bulb temperature	Wet-bulb temperature (relative humidity)	Dry-bulb temperature	Wet-bulb temperature (relative humidity)				
High	100	700					23	21 (~85%)	0.78	3.6	12.2	2.8
Medium	70	490	27	19 (~47.5%)	35	24 (~40%)	22	20.5 (~85%)	0.66	3.2	11	2.12
Low	40	280					20	19 (~90%)	0.605	2.9	10	1.77
High	100	700					19	16.5 (~78%)	0.735	2.5	8.7	1.87
Medium	70	490	27	19 (~47.5%)	27	19 (~47.5%)	18	15.5 (~78%)	0.58	2.5	8.6	1.47
Low	40	280					15	14 (~88%)	0.54	2.2	7.7	1.21

* – Important! The temperature parameters and the COP and ERR factors were defined at the temperature-humidity conditions as per the EN 13141 -7:2010 standard. The factors were calculated based on the assumption of continuous heat pump operation whereas the cyclic heat pump operation was disregarded.

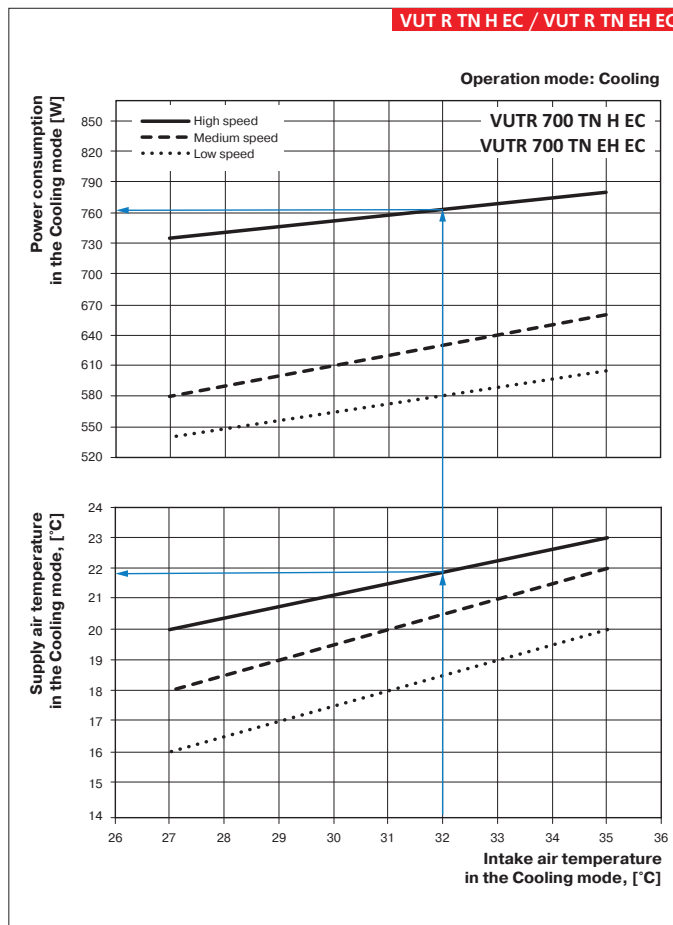

VENTS
 HEAT RECOVERY AIR HANDLING UNITS
 VUT R TN H EC /
 VUT R TN EH EC

Heat pump technical characteristics in the Heating mode:

VUT R 900 TN H EC / VUT R 900 TN EH EC												
Speed	Air flow rate		Room air temperature, [°C]		Intake air temperature, [°C]		Supply air temperature, [°C]		Electric power consumption, [kW]	COP*, W/W	COP*, BTU/W	Q _{heat} , [kW]
	% of max.	[m ³ /h]	Dry-bulb temperature	Wet-bulb temperature (relative humidity)	Dry-bulb temperature	Wet-bulb temperature (relative humidity)	Dry-bulb temperature	Wet-bulb temperature (relative humidity)				
High	100	900					26	14 (~25%)	855	6.7	22.7	5.70
Medium	70	630	20	12 (~38%)	7	6 (~86%)	28	15 (~23%)	750	5.9	20.1	4.41
Low	40	360					35	17 (~14%)	695	4.8	16.5	3.36
High	100	900					25	12 (~18%)	847	8.1	27.8	6.90
Medium	70	630	20	12 (~38%)	2	1 (~80%)	27	13 (~17%)	735	7.1	24.4	5.25
Low	40	360					34	16 (~12.5%)	680	5.6	19.3	3.84
High	100	900					20	8 (~8%)	818	11.0	37.5	9.00
Medium	70	630	20	12 (~38%)	-7	-8 (~70%)	21	9 (~8%)	700	9.3	31.7	6.51
Low	40	360					23	10 (~14%)	643	6.3	21.7	4.08

* – Important! The temperature parameters and the COP and ERR factors were defined at the temperature-humidity conditions as per the EN 13141 -7:2010 standard. The factors were calculated based on the assumption of continuous heat pump operation whereas the cyclic heat pump operation was disregarded.

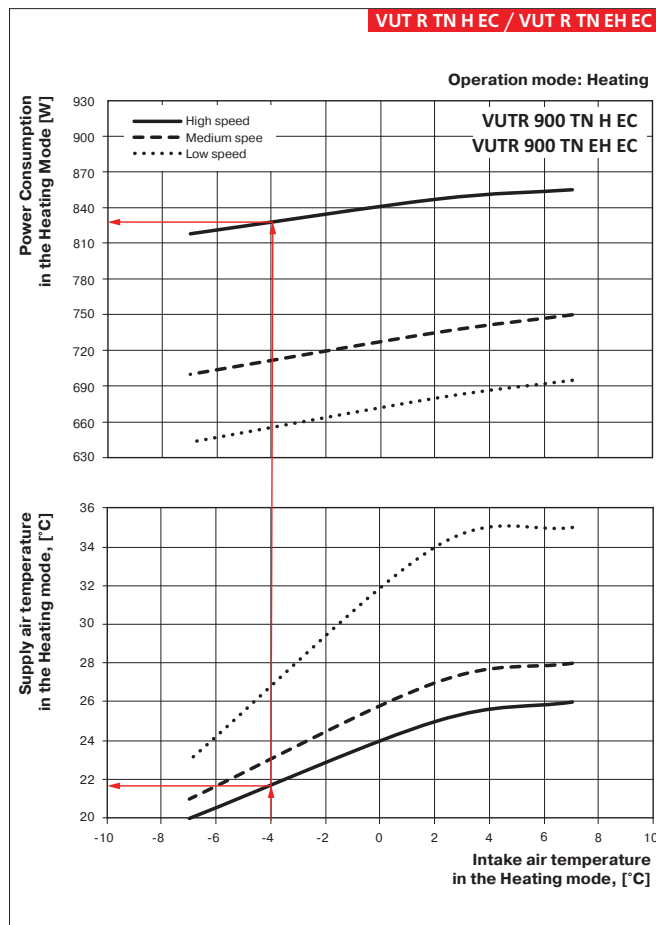

Heat pump technical characteristics in the **Cooling** mode:

VUT R 900 TN H EC / VUT R 900 TN EH EC												
Speed	Air flow rate		Room air temperature, [°C]		Intake air temperature, [°C]		Supply air temperature, [°C]		Electric power consumption, [kW]	COP*, W/W	COP*, BTU/W	Q _{heat} , kW
	% of max.	[m³/h]	Dry-bulb temperature	Wet-bulb temperature (relative humidity)	Dry-bulb temperature	Wet-bulb temperature (relative humidity)	Dry-bulb temperature	Wet-bulb temperature (relative humidity)				
High	100	900					23	21 (~85%)	0.98	3.7	12.5	3.6
Medium	70	630	27	19 (~47.5%)	35	24 (~40%)	22	20.5 (~85%)	0.87	3.1	10.7	2.73
Low	40	360					20	19 (~90%)	0.815	2.8	9.5	2.28
High	100	900					19	16.5 (~78%)	0.91	2.6	9	2.4
Medium	70	630	27	19 (~47.5%)	27	19 (~47.5%)	18	15.5 (~78%)	0.79	2.4	8.2	1.89
Low	40	360					15	14 (~88%)	0.75	2.1	7.1	1.56

* – Important! The temperature parameters and the COP and ERR factors were defined at the temperature-humidity conditions as per the EN 13141 -7:2010 standard. The factors were calculated based on the assumption of continuous heat pump operation whereas the cyclic heat pump operation was disregarded.

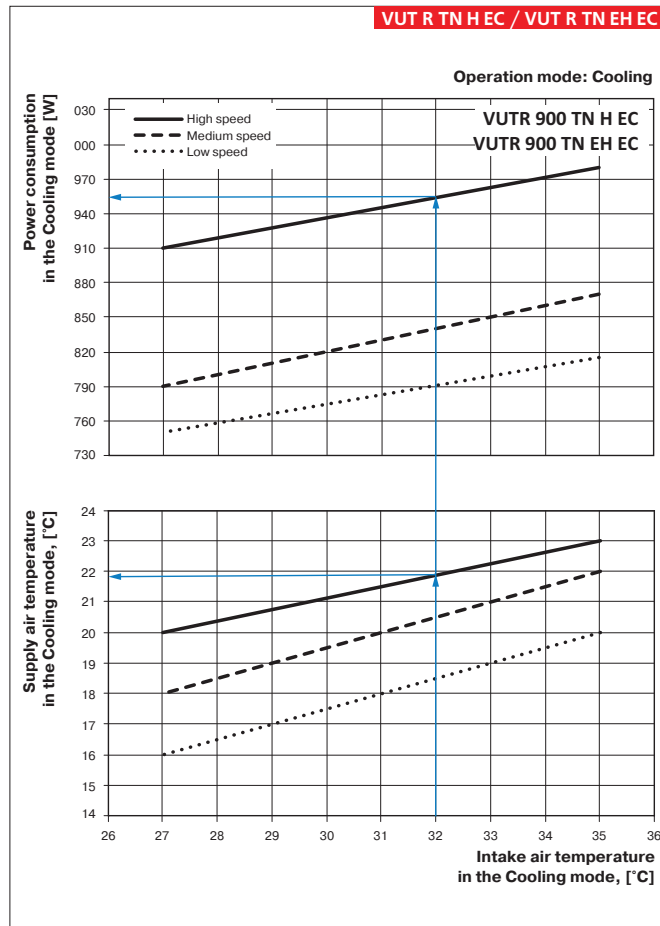

VENTS
 HEAT RECOVERY AIR HANDLING UNITS
 VUT R 900 TN H EC /
 VUT R 900 TN EH EC